

DN 80 SR

1x **80**_{kg}
176 lbs



≥20 mm
≥15/16"



Riel U21 AL
Trilho U21 AL
Carrier Track U21

Riel U100 Acero
Zincado / Riel U29
Acero Negro -
Acero Galvanizado
Trilho U100 Aço
Zincado / Trilho U29
Aço Preto - Aço
Galvanizado
Track U 100 Zinc
Plated Steel / Track
U29 Black steel -
Galvanized Steel

	H1= HV - 62 mm
	H1= HV - 55mm

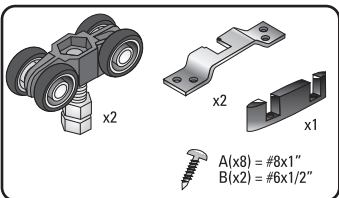
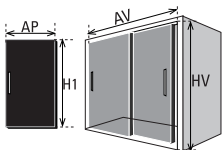

Todas las medidas expresadas en milímetros

mm	Decimal inches	Aprox Fraction	mm	Decimal inches	Aprox Fraction
1	0.0394	3/64	6	0.2362	15/64
2	0.0787	5/64	7	0.2756	9/32
3	0.1181	1/8	8	0.3150	5/16
4	0.1575	5/32	9	0.3543	23/64
5	0.1969	13/64	10	0.3937	25/64

All measurements in millimeters.

1

1.1

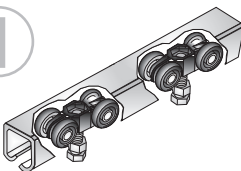

1.2

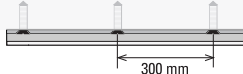

3.5 x 20mm



1.3

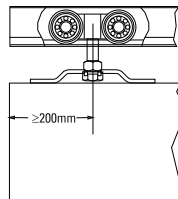
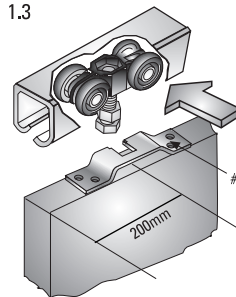

1.4

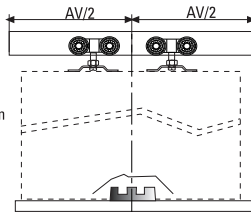
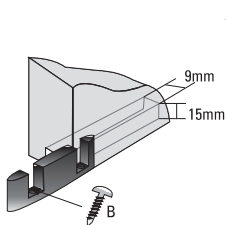

2

2.1

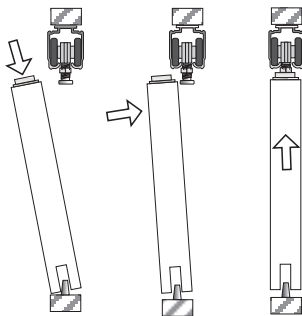

2.2

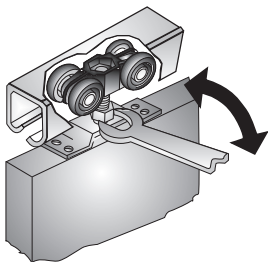

* ACCESORIOS / ACCESSORIES

Conector Muro
Conector Lateral
Wall Mounting Bracket
E = <30 mm

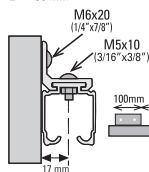

Conector Muro Ancho
Conector Lateral Largo
Wide Wall Mounting Bracket
E = <50 mm

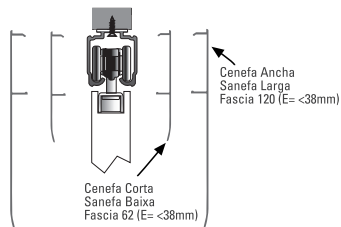
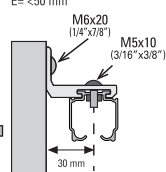

Riel Doble U21
Trilho Dobre U21
Double carrier Track U21
(E= <38mm)

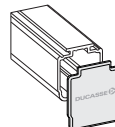
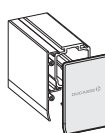
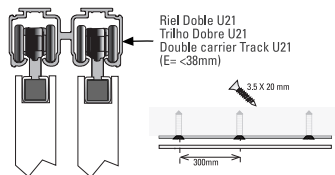

Tapa U21 CENEFa CORTA
Tampa U21 SANEFA BAIXA
U21 FASCIA 62 Cap

Tapa U21
Tampa U21
U21 Cap